

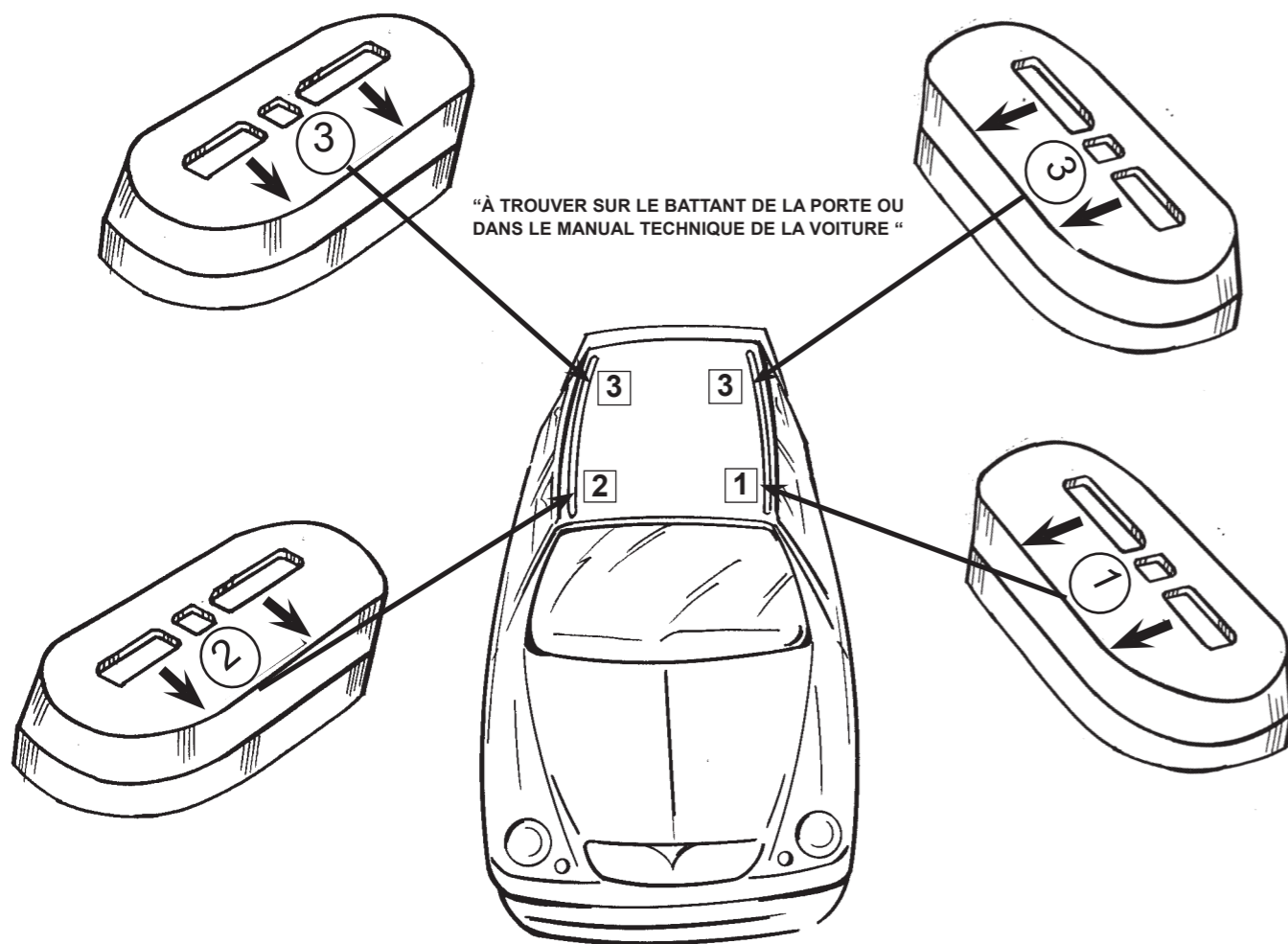

(IT) **Attenzione:** Istruzioni di montaggio per barre in alluminio.  
 (GB) **Attention:** Mounting instructions for aluminium bar carriers.  
 (E) **Atencion:** Instrucciones de montaje para barras portatodo en aluminio.  
 (D) **Achtung:** Montageanweisungen für Aluminium-Lastenträger.  
 (F) **Attention:** Notices de montage pour barres de portage en aluminium.  
 (NL) **Attentie:** Handleiding voor dakdragers gemaakt van aluminium.  
 (P) **Atenção:** Instruções de montagem para barras de tejadilho em alumínio.  
 (H) **Szerelési utasítás** alumínium tartórudakhoz.  
 (PL) **Uwaga:** Instrukcja montażu bagażników wykonanych ze aluminium.  
 (SLO) **Pozor:** Navodila za montažo nosilcev prtljažnika - aluminijastih.  
 (HR) **Uputstvo** za montažu aluminijaskih nosača.

1

FIAT: STILO 3-5P



2

**ZOOM**

**A**

(IT) SVITARE  
(GB) UNSCREW  
(E) AFLOJAR  
(D) ABSCHRAUBEN  
(F) DEVISSER  
(NL) OPENSCHROEVEN  
(P) DESAPARAFUSAR  
(H) KICSAVARNI  
(PL) WYKRECIC  
(SLO) ODVITI  
(HR) ODVITI

**B**

**C**

**D**

(IT) INFERIRE  
(GB) INSERT  
(E) CUBRIR  
(D) STOPFEN  
(F) ENFILER  
(NL) BEVESTIG

(P) INSERIR  
(H) TOLJA FEL  
(PL) NALOZIC  
(SLO) VSTAVITI  
(HR) PREKRITI

(IT) AVVITARE  
(GB) TO SCREW  
(E) APRETAR  
(D) FESTSCHRAUBEN  
(F) VISSER  
(NL) VASTSCHROEVEN

(P) APERTAR  
(H) MEGHÚZNI  
(PL) WKRECIC  
(SLO) PRIVITI  
(HR) PRIČVRSTITI

3

**ZOOM**

(IT) INFERIRE  
(GB) INSERT  
(E) CUBRIR  
(D) STOPFEN  
(F) ENFILER  
(NL) BEVESTIG

(P) INSERIR  
(H) TOLJA FEL  
(PL) NALOZIC  
(SLO) VSTAVITI  
(HR) PREKRITI

4

(IT) INFERIRE  
(GB) INSERT  
(E) CUBRIR  
(D) STOPFEN  
(F) ENFILER  
(NL) BEVESTIG  
(H) TOLJA FEL  
(PL) NALOZIC  
(SLO) VSTAVITI  
(HR) PREKRITI

**B**

(IT) TAGLIARE  
(GB) TO CUT  
(E) CORTAR  
(D) SCHNEIDEN  
(F) COUPER  
(NL) SNIJDEN  
(P) CORTAR  
(H) ELVÁGNI  
(PL) OBCIAC  
(SLO) ODREZATI  
(HR) ODREZATI

**A**

**B**

(IT) INFERIRE  
(GB) INSERT  
(E) CUBRIR  
(D) STOPFEN  
(F) ENFILER  
(NL) BEVESTIG  
(H) TOLJA FEL  
(PL) NALOZIC  
(SLO) VSTAVITI  
(HR) PREKRITI

(P) INSERIR  
(H) TOLJA FEL  
(PL) NALOZIC  
(SLO) VSTAVITI  
(HR) PREKRITI

5

(IT) TAGLIARE  
(GB) TO CUT  
(E) CORTAR  
(D) SCHNEIDEN  
(F) COUPER  
(NL) SNIJDEN  
(P) CORTAR  
(H) ELVÁGNI  
(PL) OBCIAC  
(SLO) ODREZATI  
(HR) ODREZATI

**A**

**B**

(IT) INFERIRE  
(GB) INSERT  
(E) CUBRIR  
(D) STOPFEN  
(F) ENFILER  
(NL) BEVESTIG  
(H) TOLJA FEL  
(PL) NALOZIC  
(SLO) VSTAVITI  
(HR) PREKRITI

(P) INSERIR  
(H) TOLJA FEL  
(PL) NALOZIC  
(SLO) VSTAVITI  
(HR) PREKRITI

(IT) MODELLI CON PREDISPOSIZIONE DELLA CASA AUTO  
 (GB) CARS WITH PRE-EXISTING FIXING POINT FROM MANUFACTURER  
 (E) MODELOS CON PREDISPOSICION DEL FABRICANTE  
 (D) AUTOS MIT VOM HERSTELLER VORGESEHENE BEFESTIGUNGSPUNKTE  
 (F) VOITURES AVEC POINTS DE RÉPÈRE PREVUS PAR LE CONSTRUCTEUR  
 (NL) AUTO'S MET DOOR DE FABRIKANT VOORZIENE MONTAGEPUNTEN  
 (P) VIATURAS COM PONTOS DE FIXAÇÃO DO CONSTRUTOR PRÉ-EXISTENTES  
 (H) FELHÉLYEZÉS GYÁRTÓ ÁLTAL KIJELÖLT PONTRA  
 (PL) SAMOCHODY Z PRZEWIDZIANYMI PUNKTAMI UMOCOWANIA  
 (SLO) MODELI Z PREDVIDENIM LEŽIŠČEM S STRANI PROIZVAJALCA  
 (HR) TVORNIČKI PRIPREMLJENI MODELI

6

(IT) TETTO VETTURA  
 (GB) ROOF AUTO  
 (E) TECHO DEL VEHÍCULO  
 (D) DACH AUTOMOBILE  
 (F) TOIT VOITURE  
 (NL) AUTO DAK  
 (P) TEJADILHO DA VIATURA  
 (H) AUTÓ TETÓ  
 (PL) DACH SAMOCHODU  
 (SLO) STREHA VOZILA  
 (HR) KROV AUTOMOBILA

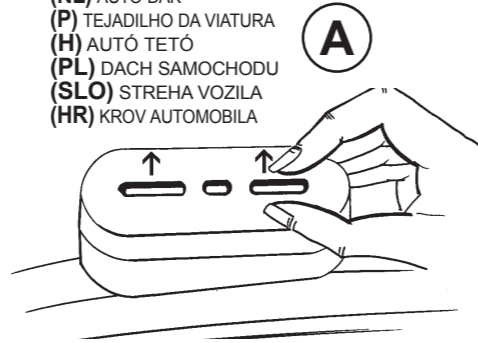

(IT) ANTERIORE  
 (GB) FRONT  
 (E) DELANTERO  
 (D) VORDERE  
 (F) AVANT  
 (NL) VOORSTE G.  
 (P) À FRENTE  
 (H) ELSÓ RÚD  
 (PL) PRZOD  
 (SLO) SPREDAJ  
 (HR) PREDNJI

B

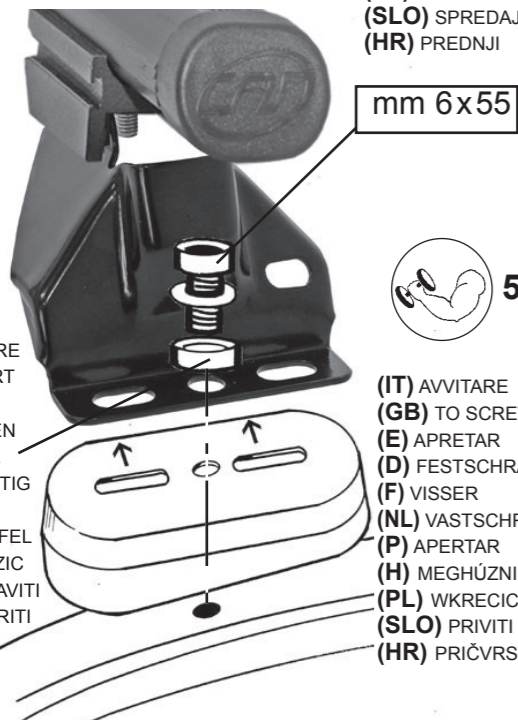

(IT) INSERIRE  
 (GB) INSERT  
 (E) CUBRIR  
 (D) STOPFEN  
 (F) ENFILER  
 (NL) BEVESTIG  
 (P) INSERIR  
 (H) TOLJA FEL  
 (PL) NALOZIC  
 (SLO) VSTAVITI  
 (HR) PREKRITI

(IT) AVVITARE  
 (GB) TO SCREW  
 (E) APRETAR  
 (D) FESTSCHRAUBEN  
 (F) VISSER  
 (NL) VASTSCHROEVEN  
 (P) APERTAR  
 (H) MEGHÚZNI  
 (PL) WKRECIC  
 (SLO) PRIVITI  
 (HR) PRIČVRSTITI

(IT) POSTERIORE  
 (GB) REAR  
 (E) TRASERO  
 (D) HINTERE  
 (F) ARRIERE  
 (NL) ACHTERSTE G.  
 (P) ATRÁS  
 (H) HÁTSÓ RÚD  
 (PL) TYL  
 (SLO) ZADAJ  
 (HR) STRAŽNJI

B

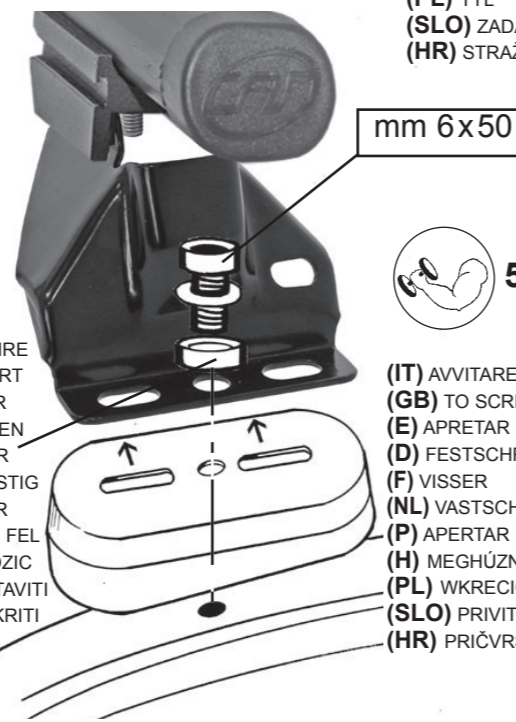

(IT) INSERIRE  
 (GB) INSERT  
 (E) CUBRIR  
 (D) STOPFEN  
 (F) ENFILER  
 (NL) BEVESTIG  
 (P) INSERIR  
 (H) TOLJA FEL  
 (PL) NALOZIC  
 (SLO) VSTAVITI  
 (HR) PREKRITI

(IT) AVVITARE  
 (GB) TO SCREW  
 (E) APRETAR  
 (D) FESTSCHRAUBEN  
 (F) VISSER  
 (NL) VASTSCHROEVEN  
 (P) APERTAR  
 (H) MEGHÚZNI  
 (PL) WKRECIC  
 (SLO) PRIVITI  
 (HR) PRIČVRSTITI

7

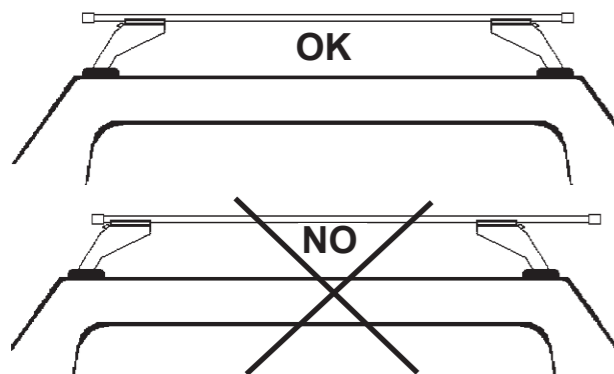

(IT) CENTRARE IL P. TUTTO SUL TETTO  
 (GB) CENTRE THE UNIVERSAL BAR CARRIER ON THE ROOF  
 (E) CENTRAR EL PORTAEQUIPAJES SOBRE EL TECHO  
 (D) LASTENTRÄGER AUF DEM DACH ZENTRIEREN  
 (F) CENTRER LE PORTE-TOUT SUR LE TOIT  
 (NL) PLAATS DE UNIVERSELE DRAGER IN HET MIDDEN VAN HET DAK  
 (P) CENTRAR AS BARRAS PORTA BAGAGENS NO TEJADILHO  
 (H) HELYEZZE KÖZÉPRE A RUDAKAT  
 (PL) WYSRODKOWAC BAGAZNIK NA DACHU  
 (SLO) CENTRIRATI PRTLJAŽNIK NA STREHO  
 (HR) CENTRIRATI NOSAČE NA KROV

8

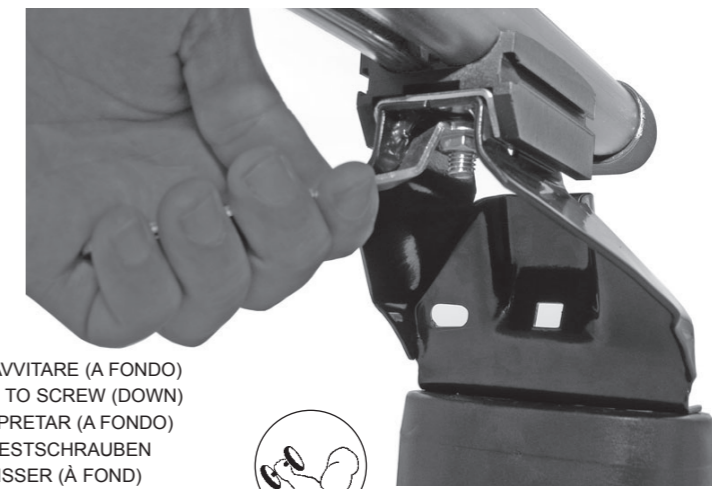

(IT) AVVITARE (A FONDO)  
 (GB) TO SCREW (DOWN)  
 (E) APRETAR (A FONDO)  
 (D) FESTSCHRAUBEN  
 (F) VISSER (À FOND)  
 (NL) VASTSCHROEVEN  
 (P) APERTAR POR BAIXO  
 (H) MEGHÚZNI  
 (PL) WKRECIC DO KONCA  
 (SLO) PRIVITI (DO KONCA)  
 (HR) PRIČVRSTITI (DO KRAJA)



10 Nm

9

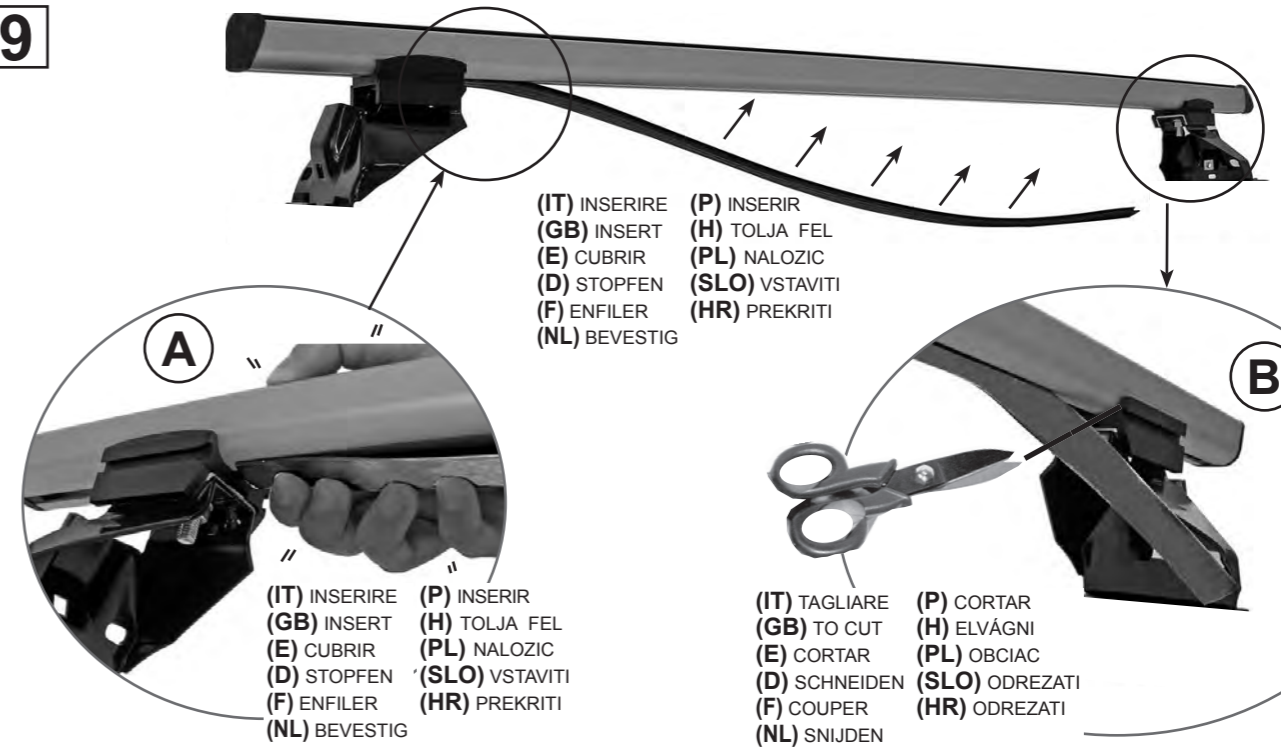

(IT) INSERIRE  
 (GB) INSERT  
 (E) CUBRIR  
 (D) STOPFEN  
 (F) ENFILER  
 (NL) BEVESTIG

(P) INSERIR  
 (H) TOLJA FEL  
 (PL) NALOZIC  
 (SLO) VSTAVITI  
 (HR) PREKRITI

A

(IT) INSERIRE  
 (GB) INSERT  
 (E) CUBRIR  
 (D) STOPFEN  
 (F) ENFILER  
 (NL) BEVESTIG

(P) INSERIR  
 (H) TOLJA FEL  
 (PL) NALOZIC  
 (SLO) VSTAVITI  
 (HR) PREKRITI

B

(IT) TAGLIARE  
 (GB) TO CUT  
 (E) CORTAR  
 (D) SCHNEIDEN  
 (F) COUPER  
 (NL) SNIJDEN

(P) CORTAR  
 (H) ELVÁGNI  
 (PL) OBCIAC  
 (SLO) ODREZATI  
 (HR) ODREZATI







(IT) **Attenzione:** Istruzioni di montaggio per barre in ferro.  
 (GB) **Attention:** Mounting instructions for steel bar carriers.  
 (E) **Atencion:** Instrucciones de montaje para barras portatodo en hierro.  
 (D) **Achtung:** Montageanweisungen für Stahl-Lastenträger.  
 (F) **Attention:** Notices de montage pour barres de portage en métal.  
 (NL) **Attentie:** Handleiding voor dakdragers gemaakt van ijzer.  
 (P) **Atenção:** Intruções de montagem para barras de tejadilho em ferro.  
 (H) Szerelési utasítás acél tartórudakhoz.  
 (PL) **Uwaga:** Instrukcja montażu bagażników wykonanych ze stali.  
 (SLO) **Pozor:** Navodila za montažo nosilcev prtljažnika-železnih.  
 (HR) Uputstvo za montažu željeznih krovnih nosača.

## 1

# FIAT: STILO 3-5P

"À TROUVER SUR LE BATTANT DE LA PORTE OU DANS LE MANUAL TECHNIQUE DE LA VOITURE "

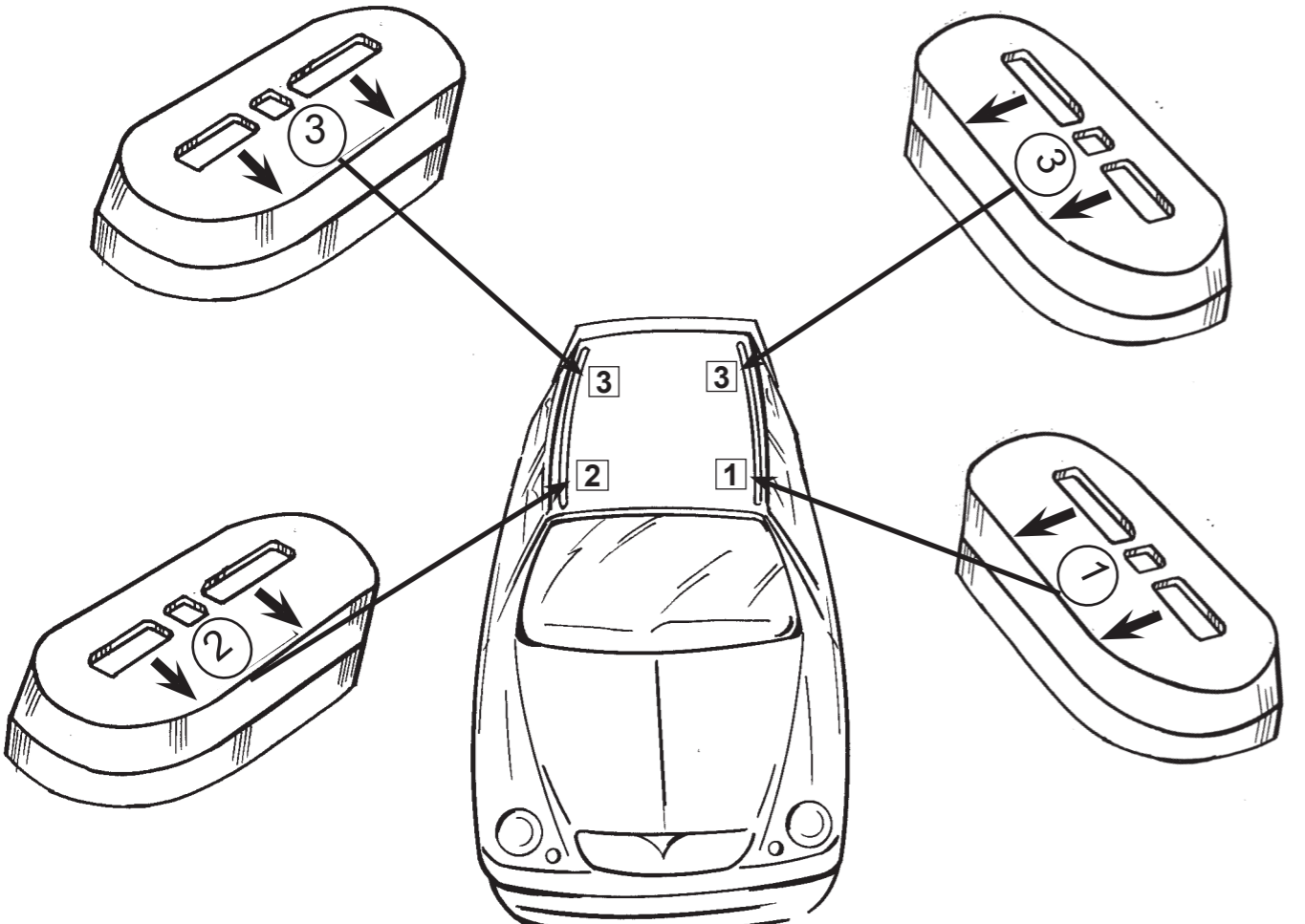

## 2

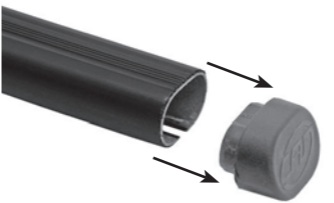

## 3

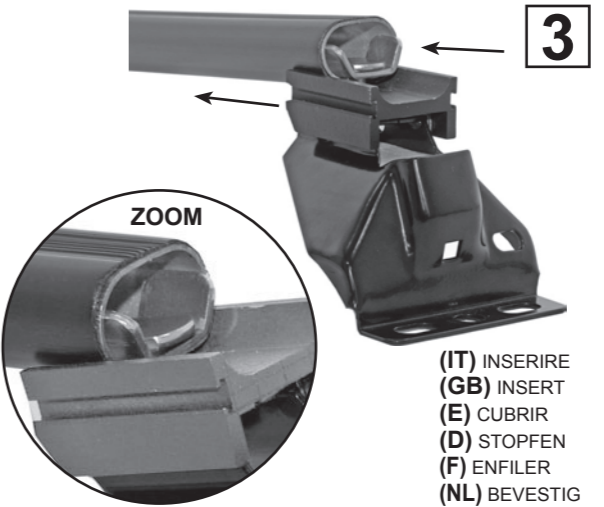

(IT) INSERIRE  
 (GB) INSERT  
 (E) CUBRIR  
 (D) STOPFEN  
 (F) ENFILER  
 (NL) BEVESTIG  
 (P) INSERIR  
 (H) TOLJA FEL  
 (PL) NALOZIC  
 (SLO) VSTAVITI  
 (HR) PREKRITI

## 4

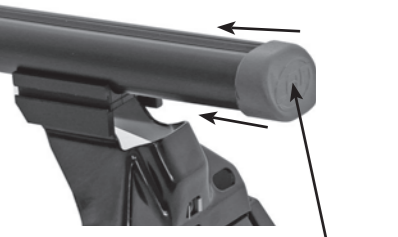

(IT) INSERIRE  
 (GB) INSERT  
 (E) CUBRIR  
 (D) STOPFEN  
 (F) ENFILER  
 (NL) BEVESTIG  
 (P) INSERIR  
 (H) TOLJA FEL  
 (PL) NALOZIC  
 (SLO) VSTAVITI  
 (HR) PREKRITI

(IT) MODELLI CON PREDISPOSIZIONE DELLA CASA AUTO  
 (GB) CARS WITH PRE-EXISTING FIXING POINT FROM MANUFACTURER  
 (E) MODELOS CON PREDISPOSICION DEL FABRICANTE  
 (D) AUTOS MIT VOM HERSTELLER VORGESEHENE BEFESTIGUNGSPUNKTE  
 (F) VOITURES AVEC POINTS DE RÉPÈRE PREVUS PAR LE CONSTRUCTEUR  
 (NL) AUTO'S MET DOOR DE FABRIKANT VOORZIENE MONTAGEPUNTEN  
 (P) VIATURAS COM PONTOS DE FIXAÇÃO DO CONSTRUTOR PRÉ-EXISTENTES  
 (H) FELHELYEZÉS GYÁRTÓ ÁLTAL KIJELÖLT PONTRA  
 (PL) SAMOCHODY Z PRZEWDZIANYMI PUNKTAMI UMOCOWANIA  
 (SLO) MODELI Z PREDVIDENIM LEŽIŠČEM S STRANI PROIZVAJALCA  
 (HR) TVORNIČKI PRIPREMLJENI MODELJI

## 5

(IT) TETTO VETTURA  
 (GB) ROOF AUTO  
 (E) TECHO DEL VEHÍCULO  
 (D) DACH AUTOMOBILE  
 (F) TOIT VOITURE  
 (NL) AUTO DAK  
 (P) TEJADILHO DA VIATURA  
 (H) AUTÓ TETÓ  
 (PL) DACH SAMOCHODU  
 (SLO) STREHA VOZILA  
 (HR) KROV AUTOMOBILA

(IT) ANTERIORE  
 (GB) FRONT  
 (E) DELANTERO  
 (D) VORDERE  
 (F) AVANT  
 (NL) VOORSTE G.  
 (P) À FRENTE  
 (H) ELSŐ RÚD  
 (PL) PRZOD  
 (SLO) SPREDAJ  
 (HR) PREDNJI

(IT) POSTERIORE  
 (GB) REAR  
 (E) TRASERO  
 (D) HINTERE  
 (F) ARRIERE  
 (NL) ACHTERSTE G.  
 (P) ATRÁS  
 (H) HÁTÓS RÚD  
 (PL) TYL  
 (SLO) ZADAJ  
 (HR) STRAŽNJI

(IT) INSERIRE  
 (GB) INSERT  
 (E) CUBRIR  
 (D) STOPFEN  
 (F) ENFILER  
 (NL) BEVESTIG  
 (P) INSERIR  
 (H) TOLJA FEL  
 (PL) NALOZIC  
 (SLO) VSTAVITI  
 (HR) PREKRITI

(IT) AVVITARE  
 (GB) TO SCREW  
 (E) APRETAR  
 (D) FESTSCHRAUBEN  
 (F) VISSER  
 (NL) VASTSCHROEVEN  
 (P) APERTAR  
 (H) MEGHÚZNI  
 (PL) WKRECIC  
 (SLO) PRIVITI  
 (HR) PRIČVRSTITI

(IT) INSERIRE  
 (GB) INSERT  
 (E) CUBRIR  
 (D) STOPFEN  
 (F) ENFILER  
 (NL) BEVESTIG  
 (P) INSERIR  
 (H) TOLJA FEL  
 (PL) NALOZIC  
 (SLO) VSTAVITI  
 (HR) PREKRITI

(IT) AVVITARE  
 (GB) TO SCREW  
 (E) APRETAR  
 (D) FESTSCHRAUBEN  
 (F) VISSER  
 (NL) VASTSCHROEVEN  
 (P) APERTAR  
 (H) MEGHÚZNI  
 (PL) WKRECIC  
 (SLO) PRIVITI  
 (HR) PRIČVRSTITI

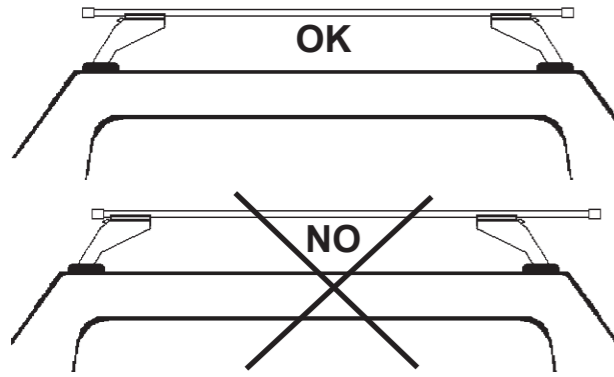
**6**

**(IT)** CENTRARE IL P. TUTTO SUL TETTO  
**(GB)** CENTRE THE UNIVERSAL BAR CARRIER ON THE ROOF  
**(E)** CENTRAR EL PORTAEQUIPAJES SOBRE EL TECHO  
**(D)** LASTENTRÄGER AUF DEM DACH ZENTRIEREN  
**(F)** CENTRER LE PORTE-TOUT SUR LE TOIT  
**(NL)** PLAATS DE UNIVERSELE DRAGER IN HET MIDDEN VAN HET DAK  
**(P)** CENTRAR AS BARRAS PORTA BAGAGENS NO TEJADILHO  
**(H)** HELYEZSE KÖZÉPRE A RUDAKAT  
**(PL)** WYSRODKOWAC BAGAZNIK NA DACHU  
**(SLO)** CENTRIRATI PRTLJAŽNIK NA STREHO  
**(HR)** CENTRIRATI NOSAČE NA KROV

**7****10 Nm**

**(IT)** AVVITARE (A FONDO)  
**(GB)** TO SCREW (DOWN)  
**(E)** APRETAR (A FONDO)  
**(D)** FESTSCHRAUBEN  
**(F)** VISSER (À FOND)  
**(NL)** VASTSCHROEVEN  
**(P)** APERTAR POR BAIXO  
**(H)** MEGHÚZNI  
**(PL)** WKRECIC DO KONCA  
**(SLO)** PRIVITI (DO KONCA)  
**(HR)** PRIČVRSTITI (DO KRAJA)

**40606 PARTS LIST**

x4 Cod. VTBS08P30



x4 Cod. 32052/Z



x4 Cod. ROZB08016



x4 Cod. DDFZ08001



x4 Cod. 60328



x4 Cod. 32053/Z

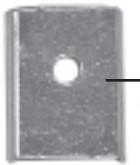

x4 Cod. 31060/V

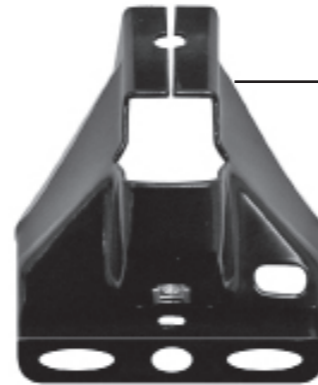

x1 Cod. 57962

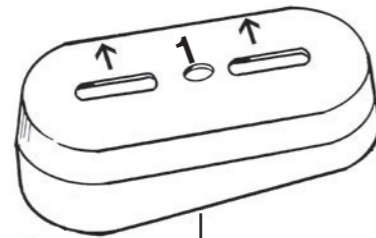

x1 Cod. 57963

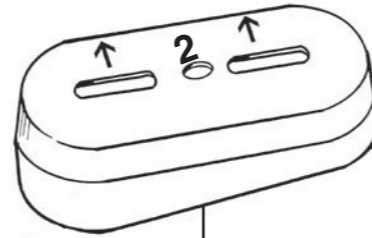

x2 Cod. 57964

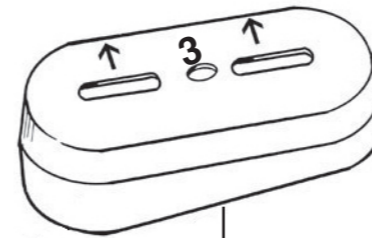

x4 Cod. 60239

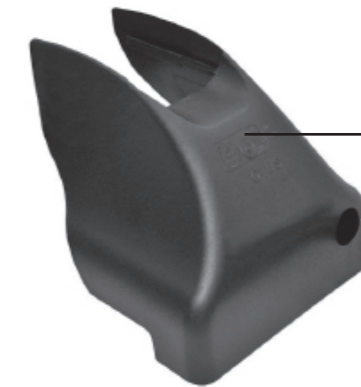

x4 Cod. 60243



x4 Cod. 60263



x1 Cod. 60273



x4 Cod. 63114

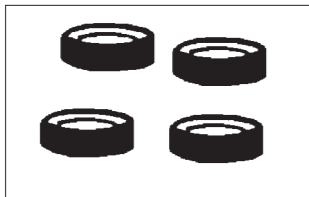

x1 Cod. 37940/M

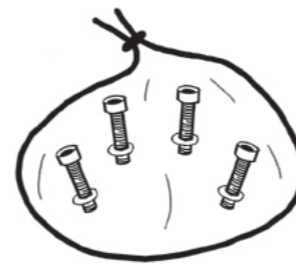

x1 Cod. 57543



x1 Cod. 32032/Z



# COVER TOTUS

(IT) ISTRUZIONI DI MONTAGGIO (GB) FITTING INSTRUCTIONS (E) INSTRUCCIONES PARA SU MONTAJE  
(D) MONTAGEANWEISUNGEN (F) INSTRUCTIONS DE MONTAGE (NL) MONTAGE INSTRUCTIES (P) INSTRUÇÕES DE MONTAGEM  
(H) SZERELÉSI UTASÍTÁS (PL) INSTRUKCJA MONTAŻU (SLO) NAVODILA O MONTAŽI (HR) UPUTE ZA MONTAŽU.

# 1



(IT) INSERIRE  
(GB) INSERT  
(E) CUBRIR  
(D) STOPFEN  
(F) ENFILER  
(P) INSERIR  
(NL) BEVESTIG  
(H) TOLJA FEL  
(PL) NALOZIC  
(SLO) VSTAVITI  
(HR) PREKRITI



# 2

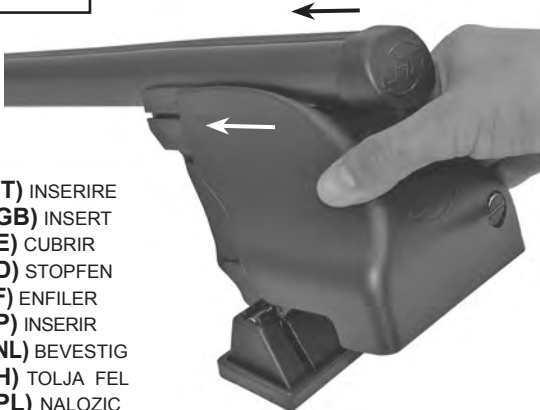

(IT) INSERIRE  
(GB) INSERT  
(E) CUBRIR  
(D) STOPFEN  
(F) ENFILER  
(P) INSERIR  
(NL) BEVESTIG  
(H) TOLJA FEL  
(PL) NALOZIC  
(SLO) VSTAVITI  
(HR) PREKRITI

# 3



# 4



(IT) INSERIRE  
(GB) INSERT  
(E) CUBRIR  
(D) STOPFEN  
(F) ENFILER  
(P) INSERIR  
(NL) BEVESTIG  
(H) TOLJA FEL  
(PL) NALOZIC  
(SLO) VSTAVITI  
(HR) PREKRITI



**NO PER ART. 40102 - 40115 - 40119**